

LINEAR LIGHT LINE

LUXYLED EVO8.5

ZERO MODULE TECHNOLOGY

CUT IT WHEREVER YOU WANT



FLEXIBILITY

HI QUALITY SILICON EXTRUSION

SLIM LUMINOUS SURFACE

PERFECT UNIFORM LIGHT



TRANSPARENT CAPS

FOR AN EXTRA LONG LIGHT

MAIN CHARACTERISTICS



- **ZERO MODULE** / Cut it in any desired point without respecting a cutting unit/module.
- Producibile with a longer terminal, cuttable on field during installation, for a perfect final fitting.
- Transparent end caps for a “zero gap” joints during extra long installations.
- Four different cable exit options.
- Produced through an advanced extra white silicon extrusion process, compared with a traditional PVC sheathing (PVC looks yellowish), lighter in terms of weight, more flexible, strong impact resistant and with a high weather resistance.
- Slimmer than the market standard 10x10mm [0,39x0,39in], it is brighter and offers a 8,5mm [0,33in] slimmer luminous surface, more discrete and easy to be inserted.
- Top and side bending version with same size to use the same accessories.
- Perfectly uniform dot-free smooth and comfortable lighting, up to 20m [65,6ft] in a single piece run length.
- IP20 and IP67 for indoor and outdoor use, can be installed on surface mount or flush mount configuration.
- UV resistant
- PWM dimmable.
- 5 year warranty (internal use) / 3 years warranty (outdoor use).
- Anodized aluminum fixing channel or brackets.

BEST ADVANTAGE

CUT IT WHEREVER YOU NEED

ZERO MODULE is a technology which allows you to **cut LUXYLED wherever you need** without respecting any fixed and predetermined cutting point. Thanks to it, each installation regardless its length and complexity, will be always and constantly perfect.

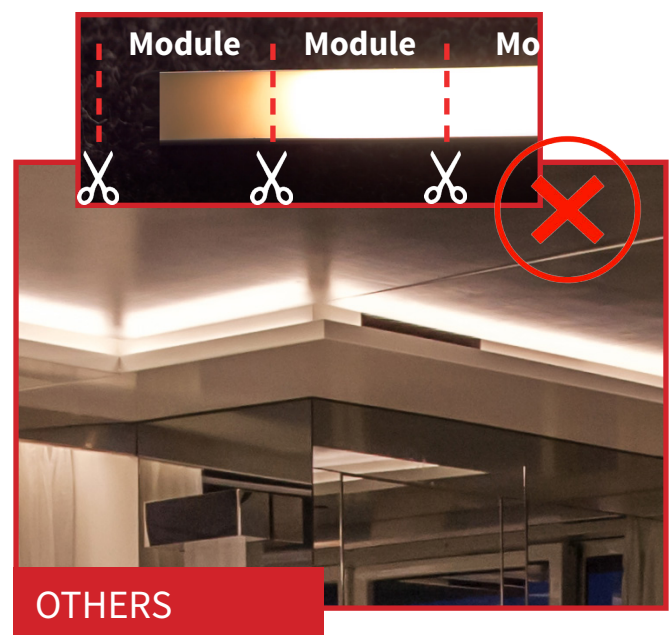
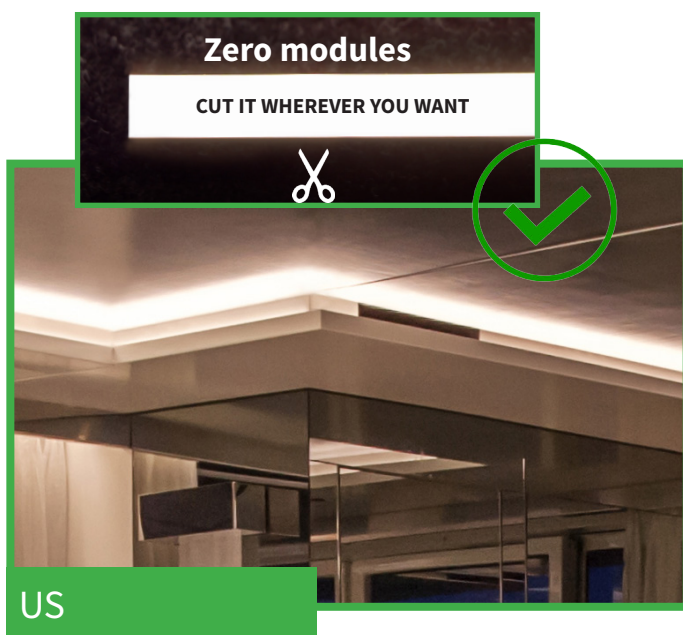

LUXLED EVO8.5 - [8,5x10mm [0,33x0,39in]]



PARAMETERS

Bending	Dimension	Cutting Unit	IP Rating	Operating temp.	Lifespan	Beam Angle	Minimum bending radius
Top Bend & Side Bend	W8,5xH10mm W0,33xH0,39in	ZERO MODULES TECHNOLOGY <i>cut it wherever you want</i>	IP20 / IP67	Ta: -20~45°C -4~113°F	50.000h(indoor) 36.000(outdoor) (L70B50 Tc ≤65°C)	120°	100mm 3,9in

W	Max. Length Single Feed	Max. Length Double Feed	V	K	Warranty (Indoor)	Warranty (Outdoor)
9W/m 2,74W/ft	5m 16,4ft	10m 32,8ft	12Vdc 24Vdc	2400K 2700K 3000K 4000K 5000K RED GREEN BLUE	5 years	3 years
5W/m 1,83W/ft	10m 32,8ft	20m 65,6ft				

PART NUMBER BUILDER

V [A]	W [B]	K [C]	BENDING [D]	POW.CAP A [E]	ENDCAP/POW.CAP B [F]
12 - 12Vdc 24 - 24Vdc	9 - 9W/m 2,74W/ft 5 - 5W/m 1,83 W/ft	24 - 2400K 27 - 2700K 30 - 3000K 40 - 4000K 50 - 5000K R - RED G - GREEN B - BLUE	T - TOP BEND S - SIDE BEND	1 - LINE 2 - SIDE LEFT 3 - SIDE RIGHT 4 - BOTTOM	X - NO END CAP [IP20] 0 - END CAP 5 - LINE 6 - SIDE LEFT 7 - SIDE RIGHT 8 - BOTTOM
EVO8.5	—	—	—	—	—

EXAMPLE : EVO8.5 2 4 9 2 7 T 3 0

[A] [B] [C] [D] [E] [F]

LENGTH → m
ft

DIMMING PROTOCOLS →

DALI	KNX	0-10	ELV / MLV	OTHERS
<input type="checkbox"/>	<input type="checkbox"/>	<input type="checkbox"/>	<input type="checkbox"/>	<input type="checkbox"/>

FIXING →

ANOD. ALUMINUM CHANNEL	BRACKET
<input type="checkbox"/> PTLUXEVO8.5ALBAR1	<input type="checkbox"/> PTLUXEVO8.5ALCLIP

DELIVERED LUMEN VALUES

LED CRI	EVO8.5 Top				EVO8.5 Side				EVO8.5	
	5W/m - 1,83 W/ft		9W/m - 2,74W/ft		5W/m - 1,83 W/ft		9W/m - 2,74W/ft		Wavelength	
	Lm/m	Lm/ft	Lm/m	Lm/ft	Lm/m	Lm/ft	Lm/m	Lm/ft		
● 2400K	93	307	94	473	144	208	63	321	98	<div style="display: flex; flex-direction: column; align-items: center;"> <div style="display: flex; align-items: center; margin-bottom: 5px;">● SINGLE RED</div> <div style="display: flex; align-items: center; margin-bottom: 5px;">● SINGLE GREEN</div> <div style="display: flex; align-items: center;">● SINGLE BLUE</div> </div>
● 2700K	94	328	100	507	155	225	69	342	104	
● 3000K	95	341	104	526	160	233	71	356	109	
○ 4000K	95	362	110	559	170	240	73	365	111	
○ 5000K	96	363	111	559	170	240	73	366	111	

CABLE EXIT

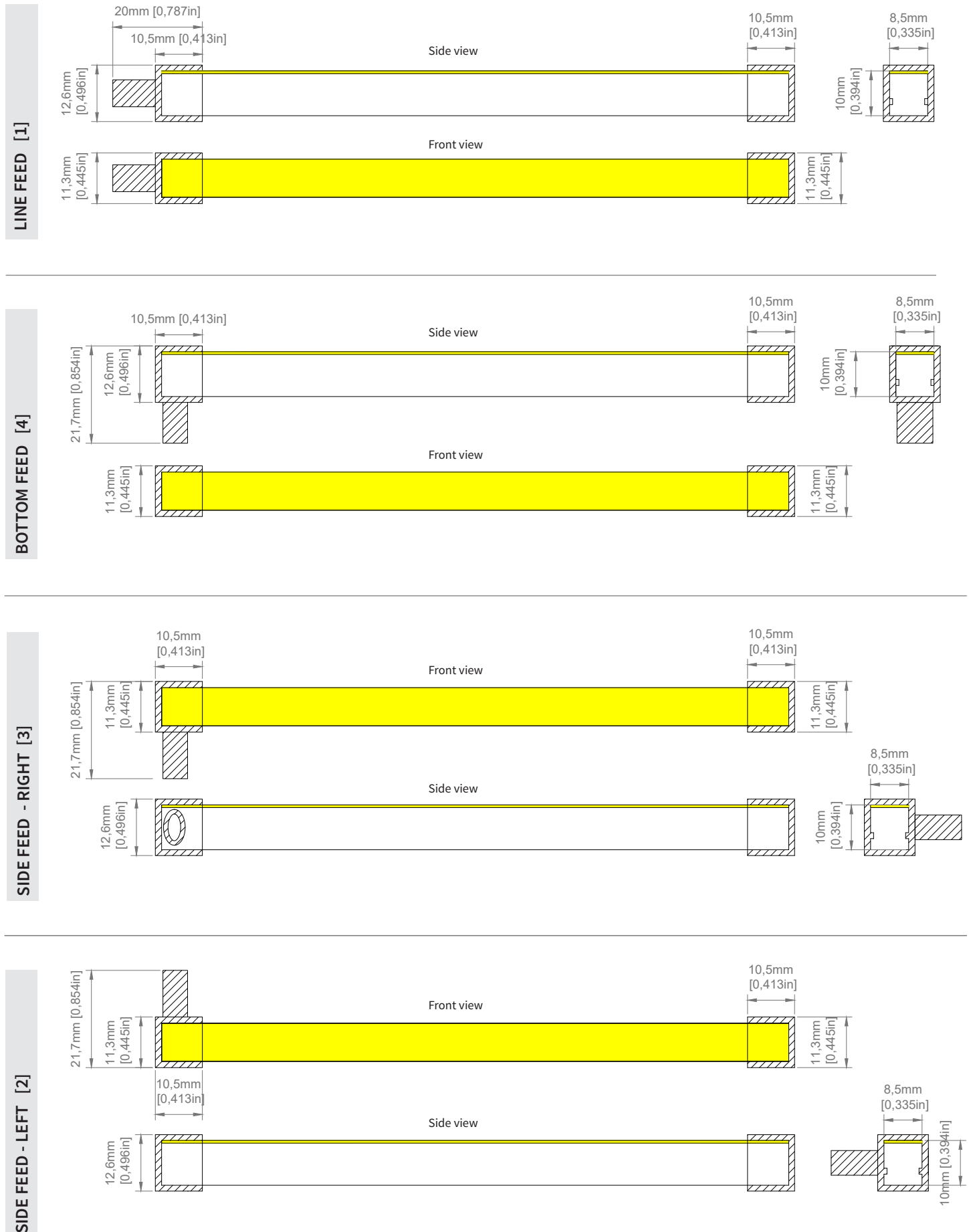

LUXYLED EVO8.5 - [8,5x10mm [0,33x0,39in]]

CABLE EXIT OPTIONS

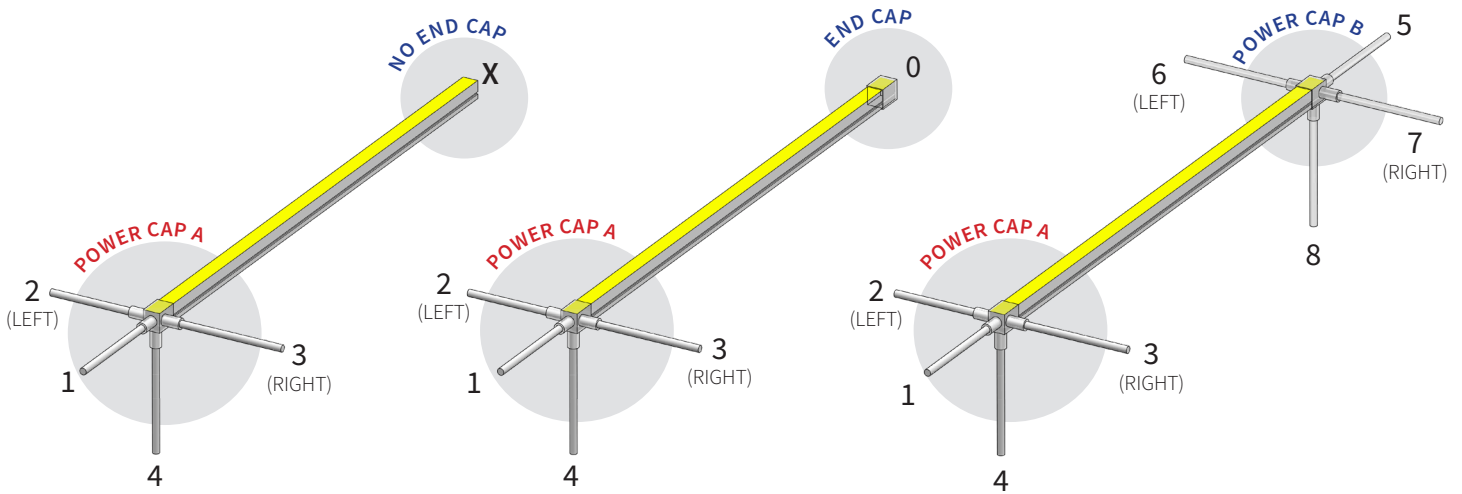

SINGLE FEED - IP20

max. 5m @ 9W/m
max. 10m @ 5W/m

SINGLE FEED - IP67

max. 5m @ 9W/m
max. 10m @ 5W/m

DOUBLE FEED - IP67

max. 10m @ 9W/m
max. 20m @ 5W/m

POWER CAP A

- 1 - LINE FEED
- 2 - SIDE LEFT FEED
- 3 - SIDE RIGHT FEED
- 4 - BOTTOM FEED

POWER CAP B / END CAP

- X - NO END CAP (IP20)
- 0 - END CAP (single feed)
- 5 - LINE FEED
- 6 - SIDE LEFT FEED
- 7 - SIDE RIGHT FEED
- 8 - BOTTOM FEED

BENDING RULES

LUXYLED EVO 8.5 SIDE BEND MINIMUM BENDING RADIUS $r > 100\text{mm}$ [3,91in]

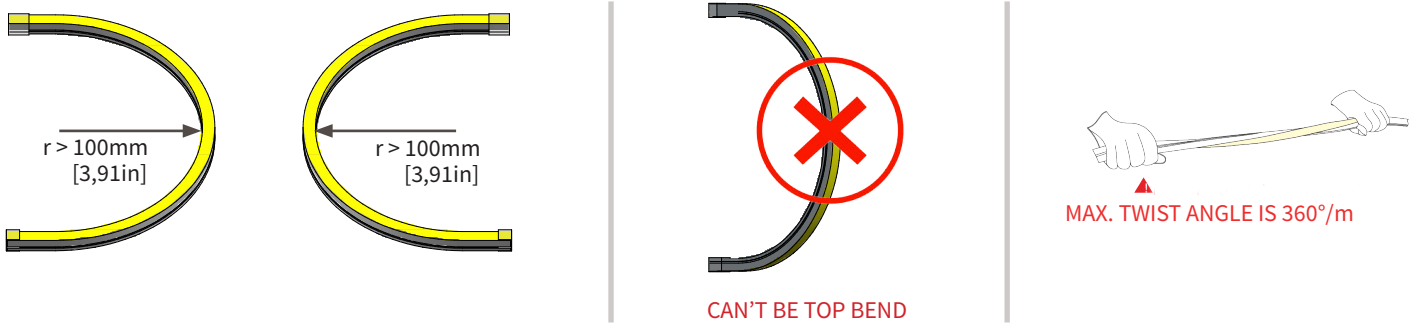

LUXYLED EVO 8.5 TOP BEND MINIMUM BENDING RADIUS $r > 100\text{mm}$ [3,91in]

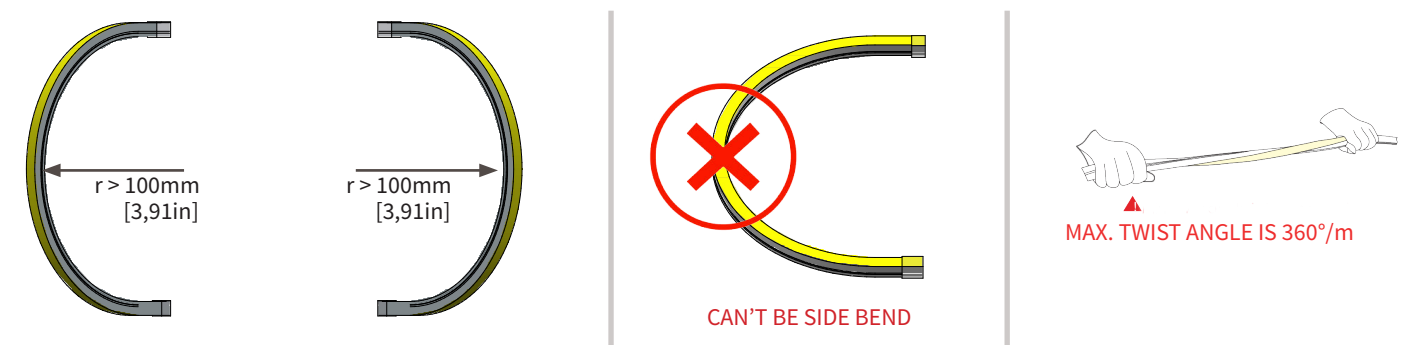

ZERO GAP

IP67 OUTDOOR APPLICATION - CAPS

TRANSPARENT CAPS

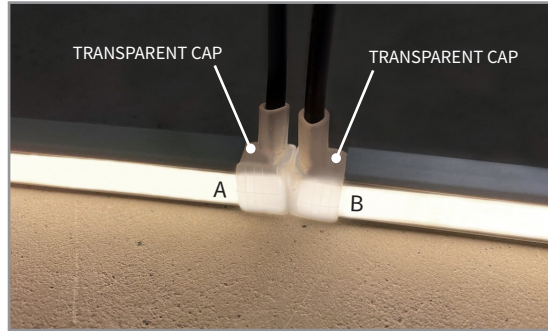
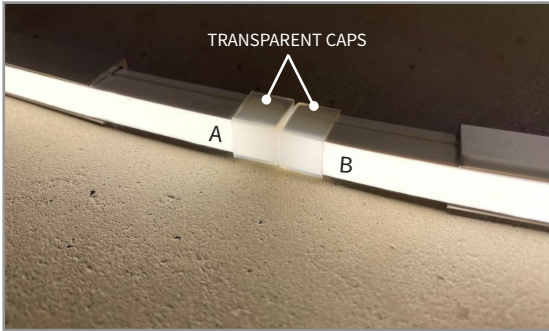
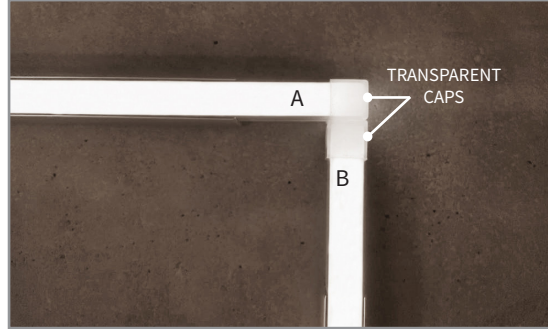
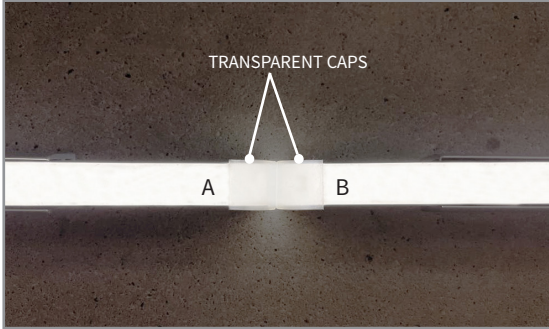
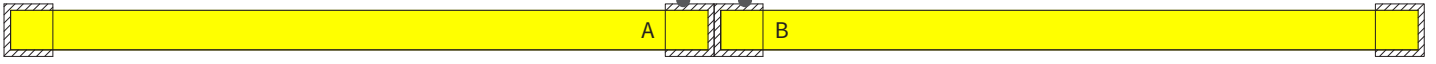

Transparent caps for a "zero gap" joint during extra long installations.

IP20 INDOOR APPLICATION - NO CAPS

A B

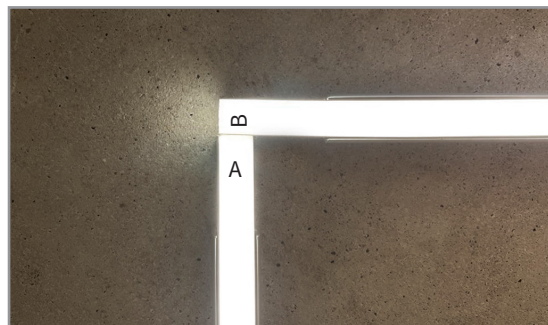
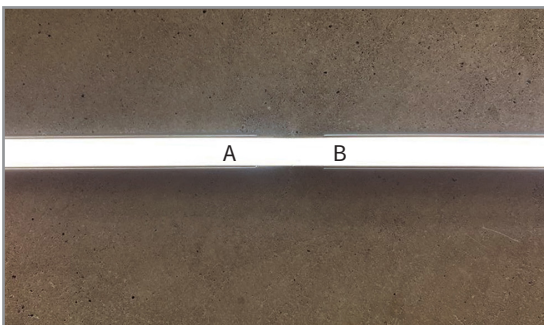
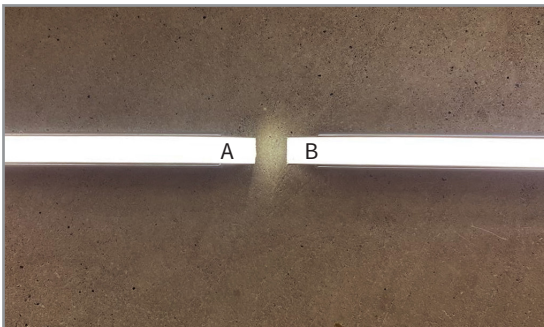

The light shines completely from the top till the end, even if you cut it. That's the reason why any joint, linear or 90° will look continuous.

FIXING ACCESSORIES

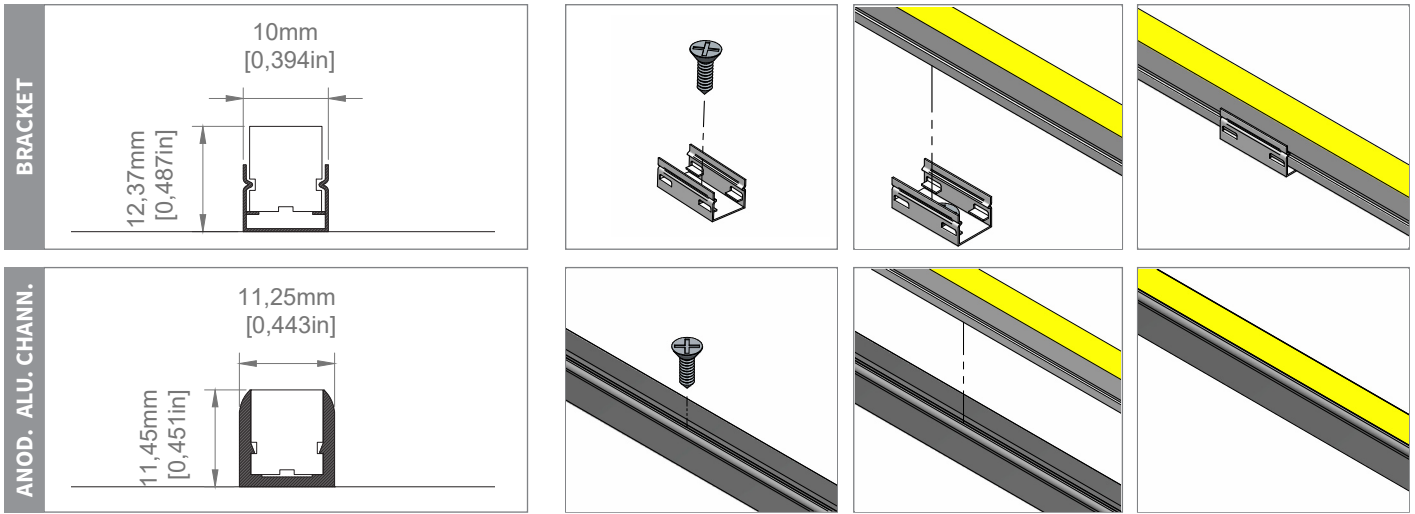

LIGHT DISTRIBUTION DIAGRAM

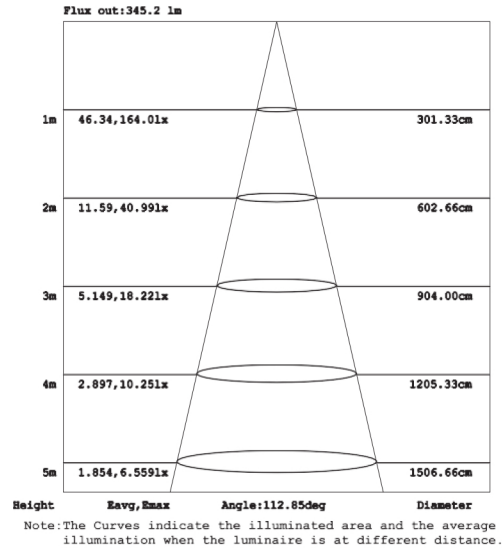
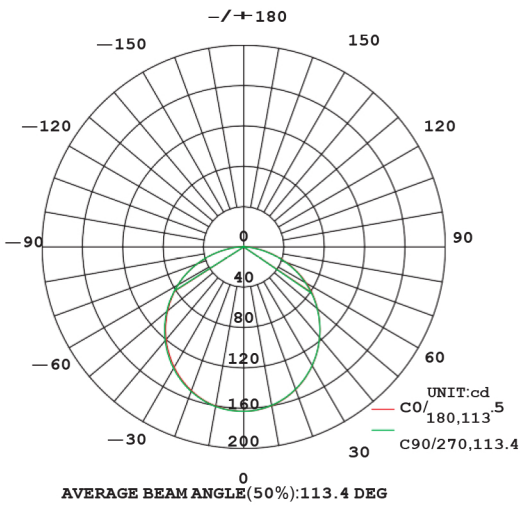

EVO8.5 / TOP BEND / 9W / 2700K

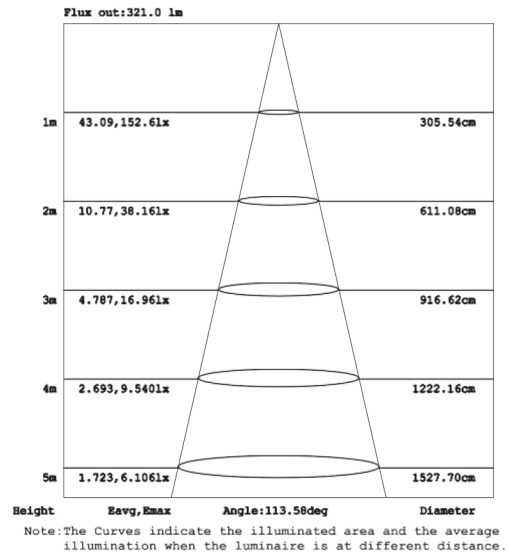
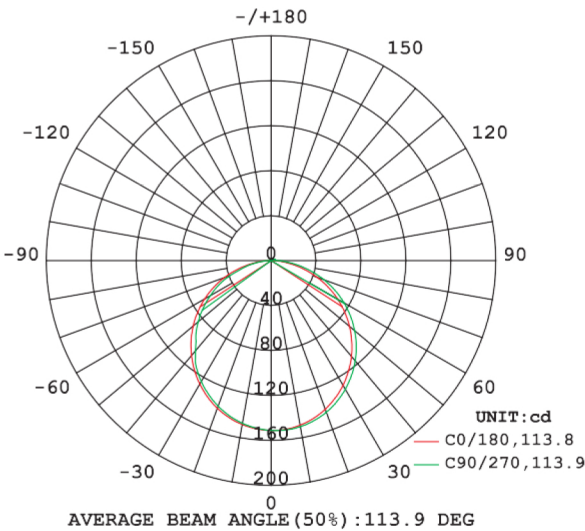

EVO8.5 / SIDE BEND / 9W / 2700K

LUXYLED COLLECTION

	SIZE (Light output from W)	SIDE BEND	TOP BEND	ZERO MODULES*	12V	24V	WHITE	TUNABLE WHITE	DIM TO WARM	RGB	RGBW	IP67	LUMEN
LUXYLED EVO4 & 4FR	W4xH8,5mm W0,16xH0,33in	●	-	●	●	●	●	-	-	-	-	●	218 lm/m 66lm/ft (4000K)
LUXYLED EVO8.5	W8,5xH10mm W0,33xH0,39in	●	●	●	●	●	●	-	-	-	-	●	559 lm/m 170lm/ft (4000K)
LUXYLED EVO8.8	W8,8xH16,5mm W0,35xH0,65in	●	-	●	-	●	●	-	-	●	●	●	350 lm/m 110lm/ft (3000K)
LUXYLED EVO10 MULTIBENDING	W10xH10mm W0,39xH0,39in	●	●	●	-	●	●	-	-	-	-	●	450 lm/m 137m/ft (4000K)
LUXYLED EVO13	W13xH13mm W0,5xH0,5in	-	●	●	-	●	●	-	-	●	-	●	830 lm/m 250lm/ft (3000K)
LUXYLED EVO19 TOP	W20xH20mm W0,79xH0,79in	-	●	-	-	●	●	●	●	●	●	●	650lm/m 198lm/ft (4000K)
LUXYLED EVO19 SIDE	W10xH20mm W0,39xH0,79in	●	-	●	-	●	●	●	●	●	●	●	535lm/m 160lm/ft (4000K)
LUXYLED EVO OMNIA	W16xH16mm W0,63xH0,63in	●	●	●	-	●	●	●	●	●	-	●	840lm/m 260lm/ft (4000K)
LUXYLED EVO OMNIA RGBW	W23xH23mm W0,9xH0,9in	●	●	-	-	-	-	-	-	-	●	●	498lm/m 152lm/ft (4000K)
LUXYLED EVO360	Ø 18mm Ø 0,71in	●	●	●	-	●	●	-	-	-	-	●	1150lm/m 350lm/ft (4000K)
LUXYLED EVO COBRA	W23xH23mm W0,9xH0,9in	●	●	-	-	●	●	●	-	-	-	●	1994lm/m 608lm/ft (4000K)
LUXYLED EVO COBRA RGB/RGBW	W34xH25mm W1,3xH0,98in	●	●	-	-	●	-	-	-	●	●	●	1186m/m 361lm/ft (4000K)

ZERO MODULE* technology not available for RBG and RGBW

CHECK HERE LUXYLED APPLICATIONS

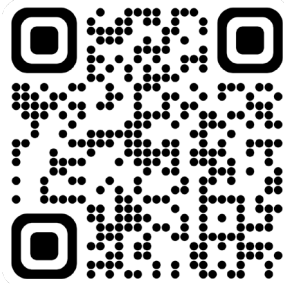

SCAN